



# KDS EZFlow 2010/2011 Micro Infusion Pump User's Manual



# **KDS EZFlow 2010/2011**

## **Contents**

General Information .....	2
General Safety Summary.....	2
Specifications.....	3
Keypad Function	
Control Panel .....	4
Keypad Description .....	5
Audible and Visual Alarms .....	5
Operation Instructions.....	6
Complete Package Contents .....	7
Storage.....	7
Parts and Accessories .....	7
Limited Warranty .....	8

# KDS EZFlow 2010/2011

## General Information

This Micro-Infusion Syringe Pump is a conventional device for research and development labs and universities. This Micro-Infusion Syringe Pump offers a reliable alternative for fluid control, especially suitable for long-term, micro fluid and precise injections.

### CAUTION

Important: User should read this entire manual before operating this micro-infusion syringe pump. **Keep this manual for future reference!**

## General Safety Summary

### WARNINGS:

- 1) Do not use a pump, syringe, or accessories that show any sign of damage.
- 2) Check the "dose calibration" switch located on the bottom of the pump every time use a new/different size/brand syringe. User must calibrate the pump before use to insure the accuracy of infusion.
- 3) Only authorized service personnel should repair this pump. Manufacturer assumes no responsibility for incidents that occur if the pump is not repaired according to manufacturer-authorized procedures.
- 4) Before connecting the syringe, user must prime the syringe and extension tube to prevent infusing air.
- 5) To clean the pump, use a damp (not wet) cloth or sponge, Do not immerse pump or power cable into water or other cleaning solution.
- 6) **Only** use the 3-Pin AC (main) power cord included with this pump. Use of any other cord presents a hazard of shock or death to subject. The AC mains outlet must be properly grounded to prevent shock hazard. Main outlet and ground should be tested on a regular basis to ensure safety. Operate away from strong magnetic fields.
- 7) This pump will go through a self diagnostic program when the power switch is turned on. Normally a "0.1" is shown in the display. This indicates the pump is operating properly. If an "ERR" is shown in the display. reboot the pump. If the error condition still exists, do not continue operation and contact manufacturer for technical service immediately.



**CAUTION**  
*Refer to Manual*



*Protective Ground  
Terminal*

# KDS EZFlow 2010/2011

## Specifications

Protection against electric shock	Type BF
Mode of operation	Continuous
Degree of protection against ingress of fluids	Drip-Proof IPX1
Acceptable syringe sizes	20/30 ml, 50/60 ml, 100 ml
Flow-rate ranges	0.1 ml/hr - 300 ml/hr in 0.1 ml/hr increments
Infusion accuracy Check	±2.5%
Operating temperature	41 °F - 104 °F (5 - 40 °C)
Relative Humidity	80% max.
Power requirements (110V version)	110VAC±10% 60 Hz 25VA or 12VDC±5%
Power requirements (220V version)	220VAC±10% 50 Hz 25VA or 12VDC±5%
Dimensions	Approx. 13" X 5.5" X 3.5" (335 X 142 X 120 mm)
Weight	5.5 pounds (2.5 kg)
Battery operation at a flow rate of 50 ml/hr, assuming fully charged battery: 4 hours	

## SYRINGE FLOW RATES

Syringe Size (ml)	Flow Rate (ml/hr)
20/30	0.1 - 150
50/60	0.1 - 300
100	0.1 - 300

This Micro-Infusion Syringe Pump uses a precision motor for injections desired fluids. Other features include:

- Self-Test, Self-Diagnoses when the pump is turned on the first time
- Audible and Visual Alarms of "Near Empty", "Complete", "Occlusion" and "Low Batt"
- Wide range of compatible syringe: 20 ml, 30 ml, 50 ml, 60 ml, 100 ml
- Wide flow rate range: 0.1 ml/hr - 300 ml/hr in 0.1ml/hr increments
- Waterproof ergonomic touch control panel

# KDS EZFlow 2010/2011

## Keypad Function: CONTROL PANEL

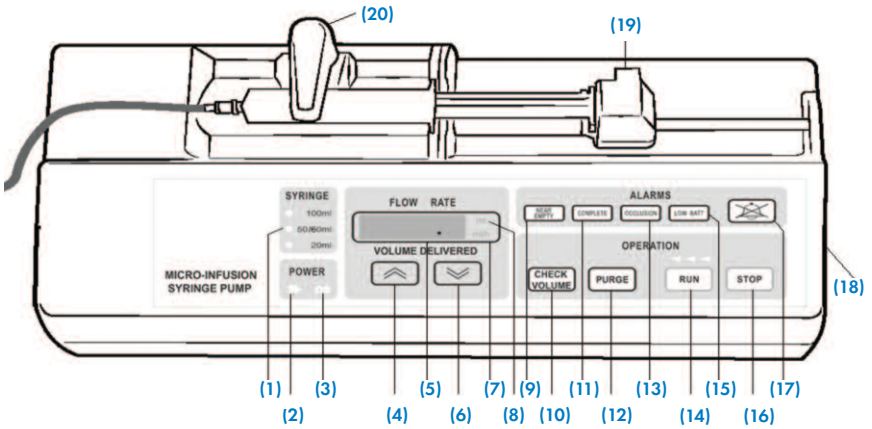





- |                            |                                 |
|----------------------------|---------------------------------|
| 1) Syringe size indicator  | 11) COMPLETE alarm indicator    |
| 2) AC POWER indicator      | 12) RAPID (PURGE)               |
| 3) BATTERY POWER indicator | 13) OCCLUSION alarm indicator   |
| 4) INCREASE rate           | 14) RUN                         |
| 5) Numeric Display         | 15) LOW BATTERY alarm indicator |
| 6) DECREASE rate           | 16) STOP                        |
| 7) FLOW rate               | 17) MUTE                        |
| 8) Delivered volume        | 18) ON/OFF switch               |
| 9) NEAR EMPTY indicator    | 19) Syringe plunger head        |
| 10) CHECK                  | 20) Syringe securing bar        |



# KDS EZFlow 2010/2011

## Keypad Function: (Continued)

### KEYPAD DESCRIPTION

	<b>INCREASE rate</b> - Increases flow rate. Press Hold to change the rate faster.								
	<b>DECREASE rate</b> - Decreases flow rate. Press Hold to change the rate faster.								
<b>CHECK</b>	<b>CHECK VOLUME</b> - Press and hold RUN mode to display the volume delivered. Release to display the preset flow rate.								
<b>RAPID</b>	<b>PURGE</b> - Only functions in STOP mode. Press to run the pump at high speed expelling air out of the syringe or to purge the syringe. Rapid purging rate varies according to syringe size: <table border="1" data-bbox="497 646 894 695"> <tr> <td><b>Syringe size (ml)</b></td> <td>20</td> <td>50/60</td> <td>100</td> </tr> <tr> <td><b>Max. flow rate (ml/hr)</b></td> <td>150</td> <td>300</td> <td>300</td> </tr> </table>	<b>Syringe size (ml)</b>	20	50/60	100	<b>Max. flow rate (ml/hr)</b>	150	300	300
<b>Syringe size (ml)</b>	20	50/60	100						
<b>Max. flow rate (ml/hr)</b>	150	300	300						
									
<b>RUN</b>	<b>RUN</b> - Press RUN button to start infusion; the LED indicator lights flash.								
<b>STOP</b>	<b>STOP</b> - Press to stop pump								
	<b>MUTE</b> - Press to silence the alarm buzzer while `NEAR EMPTY`, `COMPLETION` or `OCCLUSION` alarm is sounded. Audible and visual alarms.								

### AUDIBLE AND VISUAL ALARMS

<b>NEAR EMPTY</b>	<b>NEAR EMPTY</b> - When there is approximately 5 ml of medication left, an audible and visual alarm is activated. Press the MUTE button to silence the alarm buzzer.
<b>COMPLETE</b>	<b>COMPLETE</b> - When infusion is complete, the operation stops and audible and visual alarms are activated. Press MUTE button to silence the alarm buzzer.
<b>OCCLUSION</b>	<b>OCCLUSION</b> - Whilst occlusion occurs, operation stops. Press MUTE button to silence the alarm buzzer. Infusion only continues after the alarm condition is cleared.
<b>LOW BATT</b>	<b>LOW BATT</b> - Audible and visual alarms are activated if the battery runs low on charge. To clear the alarm, plug the power lead into an appropriate AC wall outlet. The pump will continue to operate while recharging the battery.
	<b>BATTERY POWER</b> indicator light (orange) is on to indicate that built-in battery power is in use.
	<b>AC POWER</b> indicator light (green) is on to indicate the pump is connected to main AC power and is charging battery.

# KDS EZFlow 2010/2011

## Operation Instructions

- 1) CHECK THE "DOSE CALIBRATION" SWITCH LOCATED ON THE BOTTOM OF THE PUMP EACH TIME YOU USE A NEW/DIFFERENT SIZE/BRAND SYRINGE. "Dose Calibration" switch is located on the bottom of the pump. This switch can be used to offset variances between syringes from different manufacturers as follows:

BD			Monoject		Terumo	
20ml	30ml	50/60ml	20ml	50/60ml	20ml	50/60ml
+20%	STD	+5%	+5%	+20%	+10%	STD

**IMPORTANT: ONLY ONE SWITCH CAN BE SET IN THE 'UP' POSITION. IF TWO OR MORE SWITCHES ARE SET IN THE 'UP' POSITION, THE PUMP WILL REVERT BACK TO THE 'STD' SETTING**

- 2) Pump can be used either on any horizontal surface or on the IV pole with pole clamp.
- 3) Plug power cord into a wall outlet or use the DC 12V built-in battery power. (If using battery power, charge battery at least 10 hours before use. A fully charged battery can continuously support running up to 4 hours at a flow rate of 50 ml/hr.)
- 4) Turn the power switch on. ON/OFF switch is located at the right side of the pump. When initialized, the pump will go through a Self Diagnostic program. After the pump passes the Self Diagnostic tests, "0.1" will appear on the display. If 'ERR' shows on the display the pump did not pass the power-on test and should not be used until the malfunction is corrected.
- 5) Press "Number Set Key" (up & down arrows) to set desired flow rate.
- 6) Load syringe with desired fluid. Lift up the Syringe Securing Bar and rotate right 90°. Place the syringe into the bed. Be sure to insert the nozzle into the syringe slot. Then press the release button on the plunger driver block and slide the driver block into position so that the end of the syringe plunger can be placed into the slot in the driver block. Make sure the syringe plunger is properly seated in the plunger driver block. Turn the Syringe Securing Bar to the left 90 degrees to secure the syringe barrel. Make sure the syringe barrel is secure. Press and hold the PURGE button to purge air from the syringe and associated tubing.
- 7) Press "RUN" to start infusion.
- 8) To reset the total volume delivered, power off the pump and restart.

# KDS EZFlow 2010/2011

## Complete Package Contents

110 VAC or 220 KDS EZFlow 2010 Power cord (AC mains): one piece

## Storage

This product should be stored in an environment with ambient temperature range of 14°F-131°F, (-10°C-55°C) relative humidity below 93%, and air pressure 500hpa - 1060hpa. Do not store close to corrosive vapor and/or harmful materials.

BD			Monoject		Terumo	
20ml	30ml	50/60ml	20ml	50/60ml	20ml	50/60ml
+20%	STD	+5%	+5%	+20%	+10%	STD

## IMPORTANT

### CALIBRATE FOR DIFFERENT SYRINGE !

**CHECK THE "DOSE CALIBRATION" SWITCH LOCATED ON THE BOTTOM OF THE PUMP EVERY TIME YOU USE A NEW/DIFFERENT SIZE/BRAND SYRINGE.** "Dose Calibration" switch is located on the bottom of the pump. This switch can be used to offset variances between syringes from different manufacturers as follows:

**User must do the accuracy test for OTHER brand/size syringe before use to ensure the accuracy !!!**

## Parts and Accessories

Order #	Model	Product
78-0550	EZFlow 2010	EZFlow Micro-Infusion Pump, 110 VAC
78-1550	EZFlow 2011	EZFlow Micro-Infusion Pump, 220 VAC
78-0551		IV Pole Mount
78-0593		12 VDC Power Plug Adapter

# **KDS EZFlow 2010/2011**

## **Limited Warranty**

KD Scientific Inc. warrants to the first consumer purchaser, for a period of one year from the date of purchase that this unit, when shipped in its original container, will be free from defective workmanship and materials and agree that it will, at its option, either repair or replace the defective unit.

This warranty does not extend to misuse, neglect or abuse, normal wear and tear, accident, modification or unauthorised repair.

**KD Scientific will not be liable or in any way responsible for any incidental or consequential economic or property damage.** Some States do not allow the exclusion of incidental or consequential damages, so the above exclusion may not apply to you.

**There are no implied warranties of merchantability, or fitness for a particular use, or of any other nature.** Some states do not allow this limitation on implied warranty, so the above limitation may not apply to you.

If a defect arises within the warranty period contact KD Scientific Inc., (see address below).

The customer is responsible for shipping charges and must first obtain a Return Material Authorization number (RMA) before the unit will be accepted. If a replacement unit is issued it is covered only for the remainder of the original warranty period dating from the purchase of the original device.

This warranty gives you specific legal rights. You may also have other rights which vary from state to state.

**KD Scientific Inc.,**

84 October Hill Road

Holliston, MA 01746

Phone: 508.429.6809 Fax: 508.893.0160

E-mail: [info@kdsscientific.com](mailto:info@kdsscientific.com)

Web: [www.kdsscientific.com](http://www.kdsscientific.com)

***kdScientific***

Copyright © 2009 by KD Scientific Inc. All rights reserved. Printed in USA